

DIMENSIONS MOTORPUMP "TECNIUM" BKM 11.11

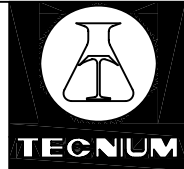

MOTOR	SPEED RATING/r.p.m.	CONSTRUCTION MATERIAL	IMPELLER	ORDER N:
NEMA-IP 55 C-flange	3480	—	—	—

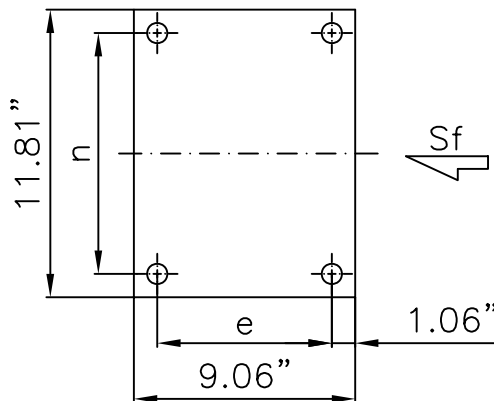
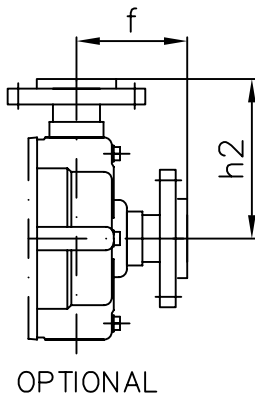
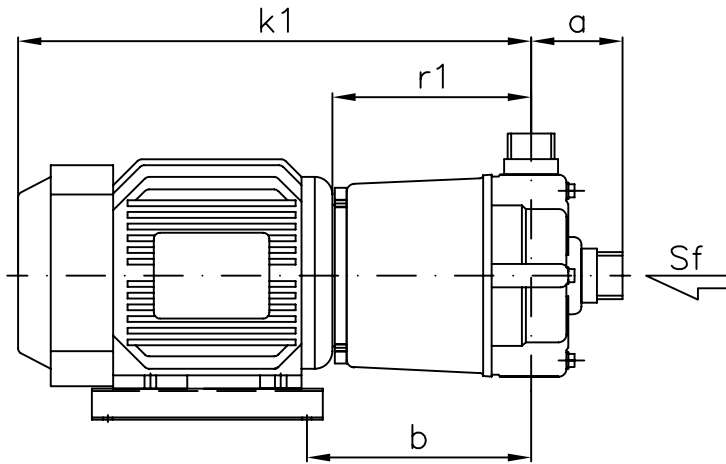
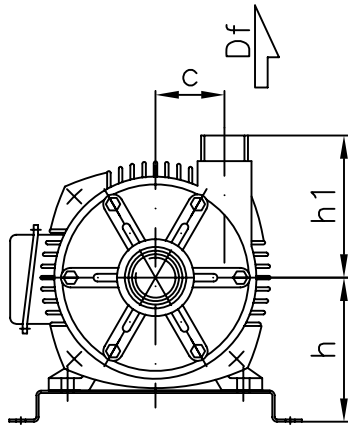

Dimensions in inches.

Pump type	Motor 145	Pump											
	HP	a	b	c	f	h	h1	h2	k1	r1	n	e	d
BKM 11.11	2	2 21/32"	7.83"	2 15/16"	4.41"	5.08"	5 1/8"	6.89"	16 15/16"	5 7/8"	7 9/32"	5 1/2"	0.47"

BRIDE OPTIONEL

Discharge Df 1 1/4"	Suction Sf 1 1/2"	Discharge Df 1 1/4"	Suction Sf 1 1/2"

Ed. 01/08

TECNIUM®

Tech. Sheet
Ht.49410