

DIMENSIONS MOTORPUMP "TECNIUM" BKM 11.11

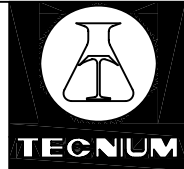

MOTOR	SPEED RATING/r.p.m.	CONSTRUCTION MATERIAL	IMPELLER	ORDER N:
NEMA-IP 55 C-flange	3480	—	—	—

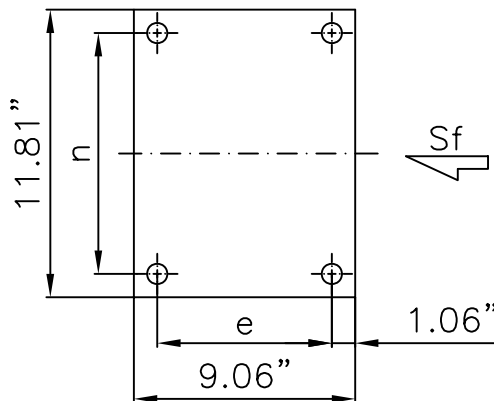
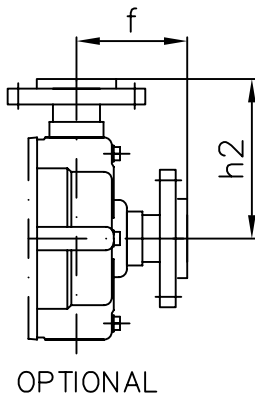
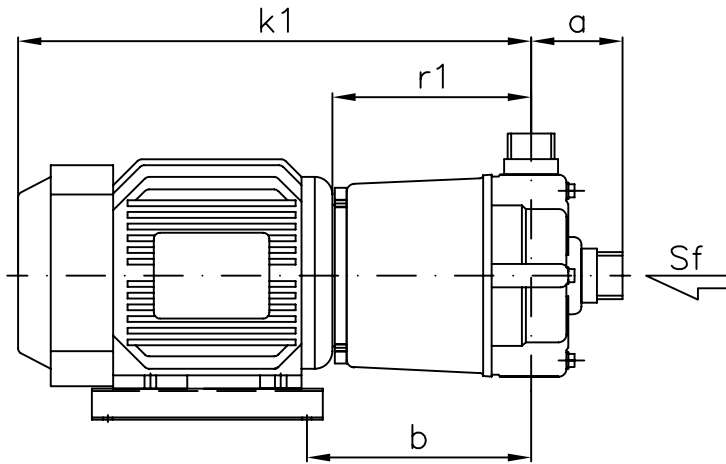
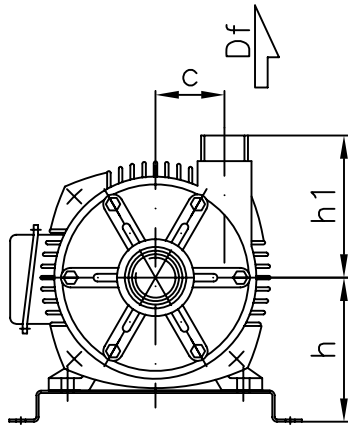

Dimensions in inches.

Pump type	Motor 182 HP	Pump											
		a	b	c	f	h	h1	h2	k1	r1	n	e	d
BKM 11.11	3	2 21/32"	9.08"	2 15/16"	4.41"	6.08"	5 1/8"	6.89"	18 1/2"	6 5/8"	8 1/16"	7 1/2"	0.47"

BRIDE OPTIONEL

Discharge Df 1 1/4"	Suction Sf 1 1/2"	Discharge Df 1 1/4"	Suction Sf 1 1/2"