

DIMENSIONS MOTORPUMP "TECNIUM" BKM 23.14

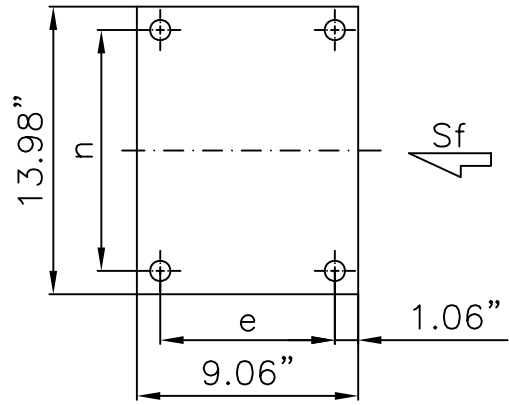

MOTOR	SPEED RATING/r.p.m.	CONSTRUCTION MATERIAL	IMPELLER	ORDER N:
NEMA-IP 55 C-flange	3480	—	—	—

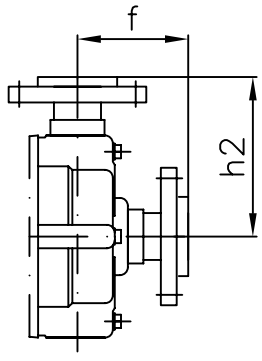
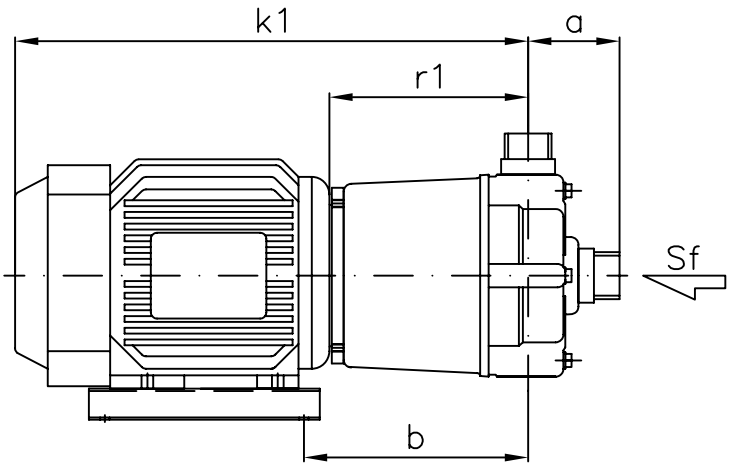
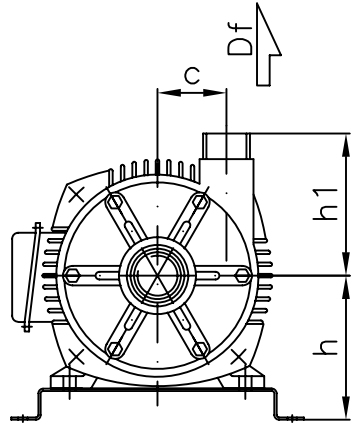

Dimensions in inches.

Pump type	Motor 184 HP	Pump											
		a	b	c	f	h	h1	h2	k1	r1	n	e	d
BKM 23.14	5	2 3/4"	10.45"	3 3/4"	4.41"	6.08"	6 1/4"	6.89"	20 13/16"	8 3/4"	8 1/16"	7 1/2"	0.47"

BRIDE OPTIONEL

Suction Sf 1 1/2"	Suction Sf 2"	Suction Sf 1 1/2"	Suction Sf 2"