

DIMENSIONS MOTORPUMP "TECNIUM" BKM 23.17

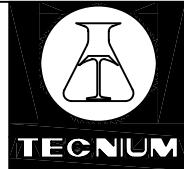

MOTOR	SPEED RATING/r.p.m.	CONSTRUCTION MATERIAL	IMPELLER	ORDER N:
NEMA-IP 55 C-flange	3480	—	—	—

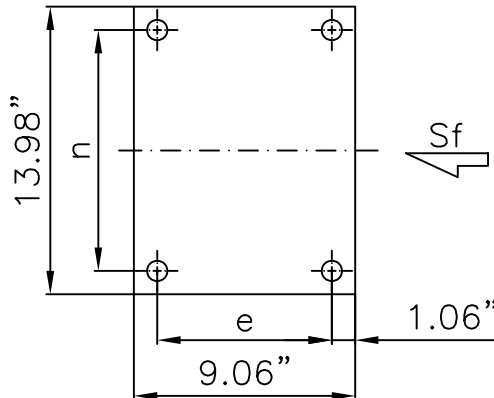
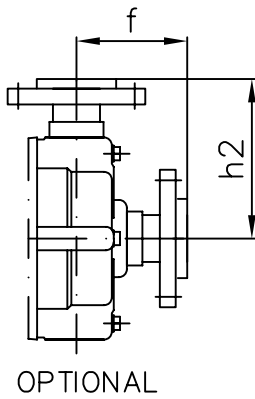
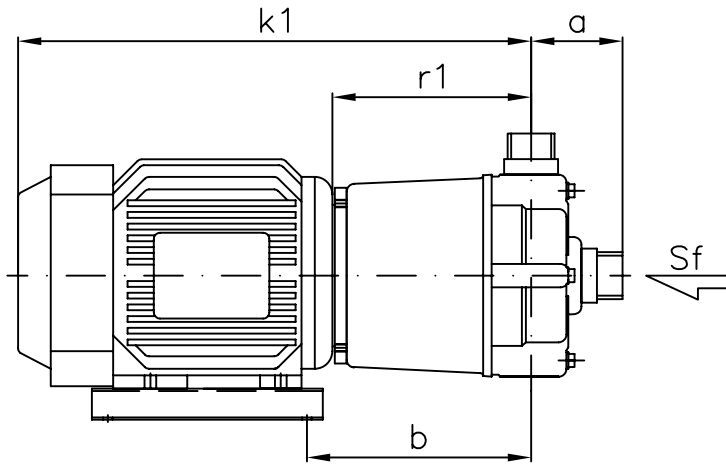
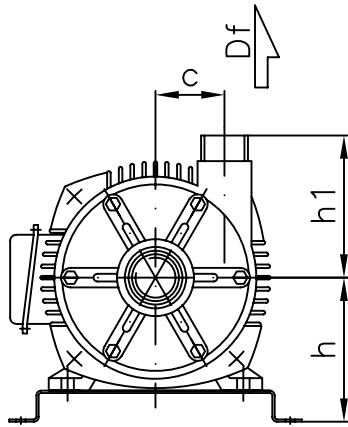

Dimensions in inches.

Pump type	Motor 215 HP	Pump											
		a	b	c	f	h	h1	h2	k1	r1	n	e	d
BKM 23.17	10	2 3/4"	11.2"	3 3/4"	4.41"	6.85"	6 1/4"	6.89"	23 1/8"	8 11/16"	10 3/8"	8 1/2"	0.47"

BRIDE OPTIONEL

Suction Sf 1 1/2"	Suction Sf 2"	Suction Sf 1 1/2"	Suction Sf 2"